

JASON[®]

HYDROTHERAPY

8328 MacArthur Dr. • North Little Rock, AR 72118
 501.771.4477 • Fax: 501.771.2333
 Customer Service: 800.255.5766
 www.jasoninternational.com

forma[®] Collection Specifications

RC553PS

MicroSilk[®]

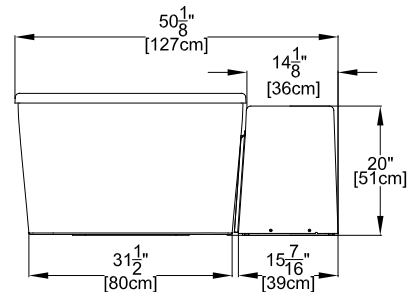
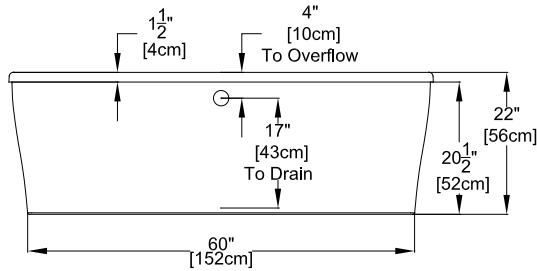
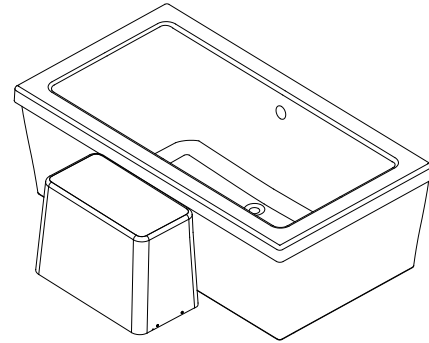
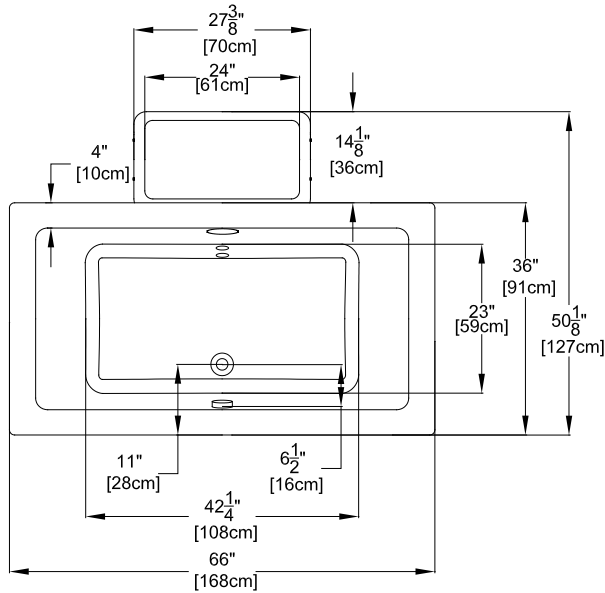

Patents received or pending.



Note: Dimensional Tolerances: ±1/4"

Drop-in-Hole Size:	N/A
Operating Capacity:	45 Gal.
Overflow Capacity:	71 Gal.
Floor Loading / sq.ft.:	54.7 lbs.
Carton Wt (Air/Soaking):	197 lbs.
Cube:	36.6 ft. ³

Acrylic Equipment Cabinet is standard on MicroSilk[®] baths.

Construction: Fiberglass reinforced acrylic bath with Level Form[™] full-support base.

We provide products listed with Intertek ETL SEMKO (Edison Testing Laboratories) U.S. and Canadian and with International Association of Plumbing and Mechanical Officials (IAPMO). Consult factory with your listing requirements.

Standard		A 120V system that includes a MicroSilk unit; an electronic control; and a 20-minute timer.
Premier		A 120V system that includes a MicroSilk unit; (2) Chromatherapy mood lights, Automatic Ozone System; an electronic control; and a 20-minute timer. The keypad also operates the LED Chromatherapy mood lights.
Signature		A 120V system that includes a MicroSilk unit, (2) Chromatherapy mood lights; Automatic Ozone System; a digital control with LCD display window; low water and water temperature sensors; and a 20-minute timer. Control keypad operates the MicroSilk [®] unit, LED Chromatherapy mood lights and shows water temperature and time remaining. Includes a floating Universal Remote Control that operates all functions of MicroSilk [®] unit and LED Chromatherapy mood lights plus TV, DVD, CD, etc.